

LED Industrial lamp, 1.2 m, 36 W, 4000K/5000K, IP66

LITH1203640, LITH1203650

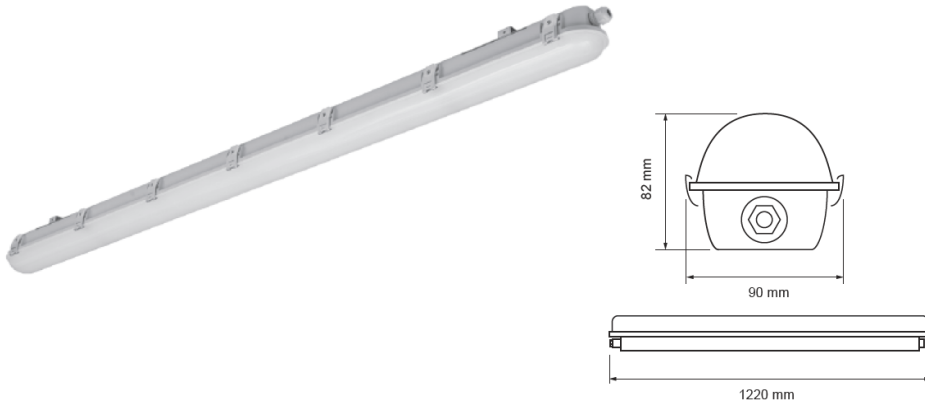

DESCRIPTION

The LED fixtures are specifically designed for industrial lighting, warehouses, indoor and outdoor spaces. The luminaires can be mounted directly on the ceiling, with the included mounting brackets or hanging on ropes. The high-energy efficiency allows high and uniform lighting at low power consumption.

BENEFITS

- High efficiency 140 lm/W
- Impact protection IK10
- High color rendering index Ra > 80
- Stainless steel clips
- Flickerless
- Housing and diffuser made of high quality polycarbonate
- Warranty period: 5 years

APPLICATION

- Warehouse lighting
- Industrial lighting
- Manufacturing facilities
- Parking lots and garages
- Indoor and outdoor use

TECHNICAL INFORMATION

Light technical information

- Efficiency: 140 lm/W
- Max. Intensity: 320 cd/klm
- Rated luminous flux: 5000 lm
- Correlated Color Temperature (CCT): 4000K / 5000K
- Color Rendering Index (CRI): Ra≥80
- Asymmetrical luminous distribution: 120°
- LED type: LG
- .LDT file is available

Electrotechnical Information

- Supply voltage: 220-240 V AC
- Frequency: 50-60 Hz
- Power factor: PF > 0.95
- Power: 36 W
- Built-in driver: OSRAM

Basic information

- IP rate: IP66
- Impact protection: IK10
- Working temperature: -20 °C ÷ +45 °C
- Lumen degradation lifetime with 20% (LM80/TM21 test report): >50 000 hours
- ON/Off Cycles: >30 000
- Dimensions: 1220/82/90mm
- Weight: 1.6 kg

